

ARGONAUT SQUARE



Square LED Emergency Light









The Argonaut Square is an IP65 and IK10 rated luminaire that is ideal for applications such as car parks, corridors, stairwells and walkways.

Market leading lithium battery technology provides lower maintenance costs and LED lamps combined with high/low sensors provides an opportunity to reduce energy costs significantly.

Constructed with a die cast aluminium body and polycarbonate diffuser the Argonaut Square provides a robust and decorative emergency lighting solution.

Applications

- | | |
|---|---|
|  Apartments |  Car Parks |
|  Factories |  Public Amenities |
|  Schools |  Sports Facilities |



Features and Benefits

- AS/NZS 2293.3 compliant
- IP65
- IK10
- Die cast aluminium body
- LED lamps
- Lithium Iron Phosphate battery
- Clevertest Plus System compatible
- Microwave sensor option



ARGONAUT SQUARE

ORDERING INFORMATION		LP		240V	
TEST OPTIONS / PART #	Standard - White	ARGOSQ-LP	ARGOSQ-SEN-LP	ARGOSQ	ARGOSQ-SEN
	Clevertest Plus System Compatible	Yes	Yes	-	-
	DALI	ARGOSQ-LP-DALI	ARGOSQ-SEN-LP-DALI	-	-
	Zoneworks® XT Hive	ARGOSQ-LP-HV	ARGOSQ-SEN-LP-HV	-	-
Carton Quantity					4
Weight - Single (Carton)	3.5kg (14.5kg)	3.5kg (14.5kg)	3.0kg (12.5kg)	3.0kg (12.5kg)	
Dimensions (L x W x H)	321mm x 321mm x 97mm				

POWER, LAMPS AND BATTERY	LP		240V	
Power Consumption (Standby / Max) - Default	0.4W / 26.6W	0.4W / 24.3W	21.2W	3.1W / 21.6W
Lamp(s)	LED Module, 4000K (L70/B50 Ta 40°C; Reported >60,000hr, Projected 205,000hr)			
Total Lumen Output	3242lm	3242lm	3242lm	3242lm
Voltage (V) /Capacity (mAh)	3.3V / 5000mAh		-	
Battery	Lithium Iron Phosphate		-	
Voltage / mAh	6.4V / 3200mAh		-	
Charging Method	Intelligent Current Limited Constant Voltage		-	

TECHNICAL SPECIFICATIONS	LP		240V		CLASSIFICATION	LP
	Operating Mode	Sustained	Non-Emergency			C0
Voltage (V) (Frequency (Hz))	220-240V (50Hz)				C90	D63
Operating Temperature	0°C to 40°C					
Ingress Protection Rating (IP)	IP65					
Impact Rating (IK)	IK10					

SPACING TABLE AND MOUNTING HEIGHTS – AS/NZS 2293.1:2018

Classification	2.1m	2.4m	2.7m	3.0m	3.3m	3.6m	4.0m	4.5m	5.0m	6.0m	7.0m	8.0m	9.0m	10.0m
D63	11.5	13.2	14.8	16.5	18.1	19.8	22	24.5	25.2	26.4	27.3	28	28.5	28.8

Care should be taken when spacing luminaires at the distances indicated by the shaded regions to ensure conformance to AS/NZS2293.1, Clause 4.3 is maintained. A single emergency luminaire shall not serve an area of greater than 500 m².

For 1 lux and AS/NZS 2293.1:2005 spacing tables please visit:
<https://clevertronics.com.au/spacing-tables/>

*Warranty information located at:
<https://clevertronics.com.au/warranty-statement/>

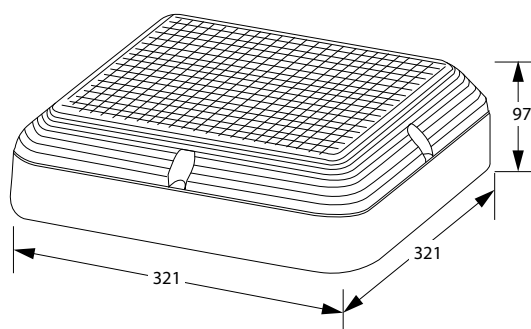

Dimensions (mm)

clevertronics.co.nz
clevertronics.com.au

1 Caribbean Drive, Scoresby VIC 3179
P +61 3 9559 2700 F +61 3 9559 2799 E info@clevertronics.com.au

Clevertronics is committed to continuously improving its products.
All features and specifications are subject to change without prior notice.
_PRODUCT SHEETS – Argonaut Square 04OCT22

